

A Better Way to Reflect Your World

Lightweight mirror panels are a much better alternative to heavy glass mirrors when you want to open up your space and provide a sense of volume if the ceiling is low or add depth to your space when the walls feel like they are closing in.

And since adding acoustic comfort is what we do, unlike glass mirror that reflects all of the sound, our standard mirror panels contribute a significant level of sound absorption to reduce noise in shops, galleries, lobbies or anywhere increased spatial volume and decreased noise levels are desirable.



Colors

Velaria Systems mirror panels are available in a range of colors to help you match the mood of the space while increasing the feeling of size and improving the acoustic performance.



Silver



Gold



Black Ivory

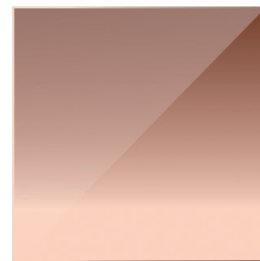

Copper

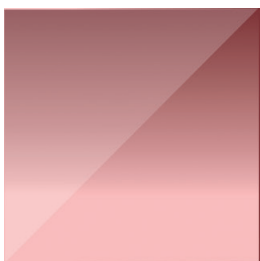

Cassis

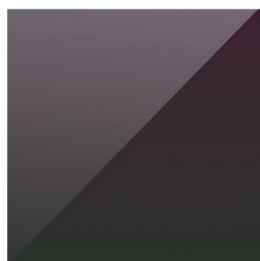

Plum

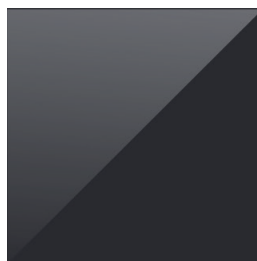

State Blue

Dimensions

Mirror panels can be easily mounted adjacent to each other to form an almost perfect continuous mirror surface.

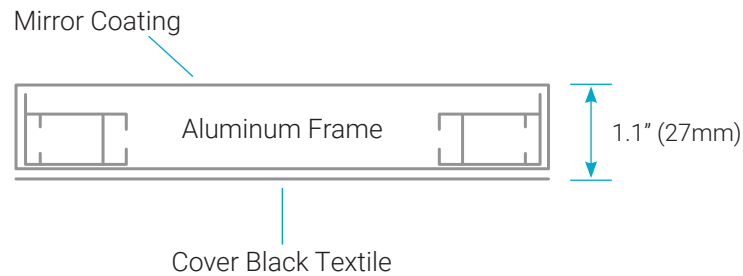

- Min. Width (W): 21.7" (550mm)
- Max. Width (W): 78.7" (2000mm)
- Min. Length (L): 21.7" (550mm)
- Max. Length (L): Standard = 94.5" (2400mm)*

*Contact Velaria Systems for additional options

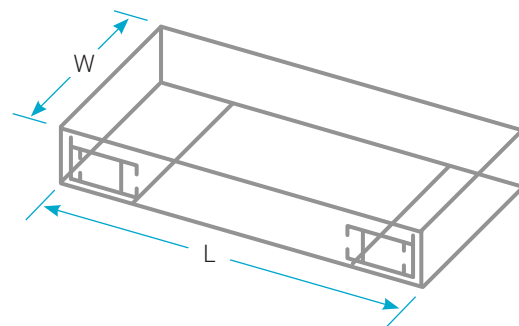

Key Features

Weight	<0.5 lb/sqft (dependent on dimensions)
Reflectivity	95%
Noise Reduction Coefficient (NRC)	0.80 (suspended acoustic option)
Material	PET with metal coating
Durability	Impact/Tear Resistant
Fire Rating	EN 13501-1: B-s1 d0
Printing	Available

Environmental

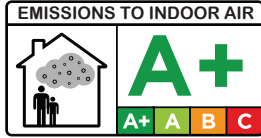

A+ rating for Volatile Organic Compounds (VOC) emissions



100% Recyclable

Certifications



CE certificate of conformity
EN 14716 1488-CPD-0106/W

CE CERTIFICATE OF CONFORMITY CE: 1488-CPD-0106/W COMPLIANCE WITH STANDARD: EN 14716:2008 (system of assessment and verification of performance constancy 1)

Specification Codes

NOTE: Specification Codes are provided for use as simple references to Velaria Systems Architectural Textile products in specifications and/or construction documents and may not include all details required to define the system. Specification Codes are NOT ordering codes. In order to receive quotations or purchase these products from Velaria Systems additional information may be required before issuing a quotation or accepting a purchase order.

<u>VS</u>	-	<u>C</u>	-	<u>MEM</u>	-	<u>Lxx.x</u>	-	<u>Wxx.x</u>
Velaria Systems		C = Ceiling		MIR = Mirror Panels		SIL = Silver GLD = Gold BLI = Black Ivory COP = Copper CAS = Cassis PLM = Plum STB = State Blue	Length xx.x = Length in inches	Width xx.x = Width in inches